

MJ26A6091 (1850 WATT)  
MJ26A6051 (1500 WATT)

# Microwave Oven

(COMMERCIAL)

## Owner's Instructions & Cooking Guide

imagine the possibilities

Thank you for purchasing this Samsung product.

Please be advised that the Samsung warranty does NOT cover service calls to explain product operation, correct improper installation, or perform normal cleaning or maintenance.

**SAMSUNG**

## CONTENTS

Using this instruction booklet.....	2
Important safety information .....	2
Legend for symbols and icons.....	2
Precautions to avoid possible exposure to excessive microwave energy..	3
Important safety instructions.....	3
Correct disposal of this product (waste electrical & electronic equipment).....	6
Installation & Wiring Instructions.....	6
Lamp (light source) .....	6
Oven .....	7
Display .....	7
Setting the time .....	7
Stopping the cooking .....	8
Cooking/Reheating.....	8
Power levels and time variations .....	9
Using +20s button.....	10
Adjusting the cooking time.....	10
Using the defrost feature.....	10
Information codes.....	11
Care of your microwave oven .....	12
Cleaning the ceiling cover .....	12
Cleaning the air filter .....	12
Installation instructions for stacking.....	12
Cookware guide .....	13
Cleaning your microwave oven .....	17
Storing and repairing your microwave oven.....	17
Technical specifications .....	18

## USING THIS INSTRUCTION BOOKLET

You have just purchased a SAMSUNG microwave oven. Your Owner's Instructions contain valuable information on cooking with your microwave oven:

- Safety precautions
- Suitable accessories and cookware
- Useful cooking tips
- Cooking tips

## IMPORTANT SAFETY INFORMATION

### IMPORTANT SAFETY INSTRUCTIONS.

#### READ CAREFULLY AND KEEP FOR FUTURE REFERENCE.

**Before using the oven, confirm that the following instructions are followed.**

- Use this appliance only for its intended purpose as described in this instruction manual. Warnings and Important Safety Instructions in this manual do not cover all possible conditions and situations that may occur. It is your responsibility to use common sense, caution, and care when installing, maintaining, and operating your appliance.
- Because these following operating instructions cover various models, the characteristics of your microwave oven may differ slightly from those described in this manual and not all warning signs may be applicable. If you have any questions or concerns, contact your nearest service centre or find help and information online at [www.samsung.com](http://www.samsung.com).
- This microwave oven is supposed for heating food. It is intended for domestic home-use only. Do not heat any type of textiles or cushions filled with grains, which could cause burns and fire. The manufacturer cannot be held liable for damage caused by improper or incorrect use of the appliance.
- Failure to maintain the oven in a clean condition could lead to deterioration of the surface that could adversely affect the life of the appliance and possible result in a hazardous situation.

## LEGEND FOR SYMBOLS AND ICONS















**WARNING**

Hazards or unsafe practices that may result in **severe personal injury or death**.



**CAUTION**

Hazards or unsafe practices that may result in **minor personal injury or property damage**.

	Warning; Fire hazard		Warning; Hot surface
	Warning; Electricity		Warning; Explosive material
	Do NOT attempt.		Follow directions explicitly.
	Do NOT disassemble.		Unplug the power plug from the wall socket.
	Do NOT touch.		Make sure the machine is grounded to prevent electric shock.
	Call the service center for help.		Note
	Important		

## PRECAUTIONS TO AVOID POSSIBLE EXPOSURE TO EXCESSIVE MICROWAVE ENERGY.

Failure to observe the following safety precautions may result in harmful exposure to microwave energy.

- (a) Under no circumstances should any attempt be made to operate the oven with the door open or to tamper with the safety interlocks (door latches) or to insert anything into the safety interlock holes.
- (b) Do NOT place any object between the oven door and front face or allow food or cleaner residues to accumulate on sealing surfaces. Ensure that the door and door sealing surfaces are kept clean by wiping after use first with a damp cloth and then with a soft dry cloth.
- (c) Do NOT operate the oven if it is damaged until it has been repaired by a qualified microwave service technician trained by the manufacturer. It is particularly important that the oven door closes properly and that there is no damage to the:
  - (1) door (bent)
  - (2) door hinges (broken or loose)
  - (3) door seals and sealing surfaces
- (d) The oven should not be adjusted or repaired by anyone other than a properly qualified microwave service technician trained by the manufacturer.

This product is a Group 2 Class B ISM equipment. The definition of group 2 which contains all ISM equipment in which radio-frequency energy is intentionally generated and/or used in the form of electromagnetic radiation for the treatment of material, and EDM and arc welding equipment.

For Class B equipment is equipment suitable for use in domestic establishments and in establishments directly connected to a low voltage power supply network which supplies buildings used for domestic purposes.

## IMPORTANT SAFETY INSTRUCTIONS

Make sure that these safety precautions are obeyed at all times.





 <b>WARNING</b>					
	Only qualified staff should be allowed to modify or repair the microwave oven.	✓	✓	✓	✓
	Do not heat liquids and other food in sealed containers for microwave function.	✓	✓	✓	✓
	For your safety, do not use high-pressure water cleaners or steam jet cleaners.	✓	✓	✓	✓
	Do not install this appliance; near heater, inflammable material; in a humid, oily or dusty location, in a location exposed to direct sunlight and water or where gas may leak; on an level ground.	✓	✓	✓	✓
	This appliance must be properly grounded in accordance with local and national codes.	✓	✓	✓	✓
	Remove all foreign substances such as dust or water from the power plug terminals and contact points using a dry cloth on a regular basis.	✓	✓	✓	✓
	Do not pull or excessively bend or place heavy object on the power cord.	✓	✓	✓	✓
	In the event of a gas leak (such as propane gas, LP gas, etc.), ventilate immediately without touching the power plug.	✓	✓	✓	✓
	Do not touch the power plug with wet hands.	✓	✓	✓	✓
	Do not turn the appliance off by unplugging the power plug while an operation is in progress.	✓	✓	✓	✓
	Do not insert fingers or foreign substances. If any foreign substance such as water has entered the appliance, unplug the power plug and contact your nearest service centre.	✓	✓	✓	✓
	Do not apply excessive pressure or impact to the appliance.	✓	✓	✓	✓
	Do not place the oven over a fragile object such as a sink or glass object. (Counter top model only.)	✓	✓		
	Do not use benzene, thinner, alcohol, steam cleaner or high pressure cleaner to clean the appliance.	✓	✓	✓	✓
	Ensure that the power voltage, frequency and current are the same as those of the product specifications.	✓	✓		✓

<input type="checkbox"/>	Plug the power plug into the wall socket firmly. Do not use a multiple plug adapter, an extension cord or an electric transformer.	✓	✓	✓	
<input type="checkbox"/>	Do not hook the power cord on a metal object, insert the power cord between the objects or behind the oven.	✓	✓	✓	
<input type="checkbox"/>	Do not use a damaged power plug, damaged power cord or loose wall socket. When the power plug or power cord is damaged, contact your nearest service centre.	✓	✓	✓	✓
<input type="checkbox"/>	Appliances are not intended to be operated by means of an external timer or separate remote-control system.	✓	✓		
<input type="checkbox"/>	Do not pour or directly spray water onto the oven.	✓	✓		
<input type="checkbox"/>	Do not place objects on the oven, inside or on the door of the oven.	✓	✓	✓	
<input type="checkbox"/>	Do not spray volatile material such as insecticide onto the surface of the oven.	✓	✓		
<input checked="" type="checkbox"/>	Children should be supervised to ensure that they do not play with the appliance. Keep children away from the door when opening or closing it as they may bump themselves on the door or catch their fingers in the door.	✓	✓	✓	✓
<input type="checkbox"/>	The appliance is not intended for installing in road vehicles, caravans and similar vehicles etc.	✓	✓	✓	✓
<input type="checkbox"/>	Do not store flammable materials in the oven. Take special care when heating dishes or drinks that contain alcohol as alcohol vapours may contact a hot part of the oven.	✓		✓	✓
<input type="checkbox"/>	The microwave oven is intended to be used on the counter or counter top use only, the microwave oven shall not be placed in a cabinet. (Counter top model only.)	✓	✓	✓	✓
<input checked="" type="checkbox"/>	<b>WARNING:</b> The appliance and its accessible parts become hot during use. Care should be taken to avoid touching heating elements. Children less than 8 years of age shall be kept away unless continuously supervised.	✓	✓	✓	✓
<input checked="" type="checkbox"/>	<b>WARNING:</b> Only allow children to use the oven without supervision when adequate instructions have been given so that the child is able to use the oven in a safe way and understands the hazards of improper use.	✓	✓	✓	✓
<input checked="" type="checkbox"/>	This appliance can be used by children aged from 8 years and above and persons with reduced physical, sensory or mental capabilities or lack of experience and knowledge if they have been given supervision or instruction concerning use of the appliance in a safe way and understand the hazards involved. Children shall not play with the appliance. Cleaning and user maintenance shall not be made by children without supervision.	✓	✓	✓	✓

<input type="checkbox"/>	<b>WARNING:</b> If the door or door seals are damaged, the oven must not be operated until it has been repaired by a competent person.	✓	✓	✓	✓
<input type="checkbox"/>	<b>WARNING:</b> It is hazardous for anyone other than a competent person to carry out any service or repair operation that involves the removal of a cover which gives protection against exposure to microwave energy.	✓	✓	✓	✓
<input type="checkbox"/>	<b>WARNING:</b> Ensure that the appliance is switched off before replacing the lamp to avoid the possibility of electric shock.	✓	✓	✓	
<input type="checkbox"/>	<b>WARNING:</b> Liquids and other foods must not be heated in sealed containers since they are liable to explode.	✓		✓	✓
<input type="checkbox"/>	<b>WARNING:</b> Accessible parts may become hot during use. To avoid burns young children should be kept away.	✓		✓	
<input checked="" type="checkbox"/>	<b>WARNING:</b> Microwave heating of beverages can result in delayed eruptive boiling, therefore care must be taken when handling the container; To prevent this situation ALWAYS allow a standing time of at least 20 seconds after the oven has been switched off so that the temperature can equalize. Stir during heating, if necessary, and ALWAYS stir after heating. In the event of scalding, follow these FIRST AID instructions: <ul style="list-style-type: none"> <li>Immerse the scalded area in cold water for at least 10 minutes.</li> <li>Cover with a clean, dry dressing.</li> <li>Do not apply any creams, oils or lotions.</li> </ul>	✓	✓	✓	✓
<input checked="" type="checkbox"/>	During use the appliance becomes hot. Care should be taken to avoid touching heating elements inside the oven.	✓		✓	✓
<input checked="" type="checkbox"/>	<b>WARNING:</b> The contents of feeding bottles and baby food jars shall be stirred or shaken and the temperature checked before consumption, in order to avoid burns;			✓	
<input checked="" type="checkbox"/>	The appliance is not intended for use by persons (including children) with reduced physical, sensory or mental capabilities, or lack of experience and knowledge, unless they have been given supervision or instruction concerning use of the appliance by a person responsible for their safety.	✓	✓	✓	✓
<input checked="" type="checkbox"/>	This oven should be positioned proper direction and height permitting easy access to cavity and control area.	✓	✓	✓	✓
<input checked="" type="checkbox"/>	Before using the your oven first time, oven should be operated with the water during 10 minute and then used.	✓	✓	✓	✓
<input checked="" type="checkbox"/>	This microwave oven has to be positioned so that plug is accessible. If the oven generates a strange noise, a burning smell, or smoke is emitted, unplug the power plug immediately and contact your nearest service center.	✓	✓	✓	✓

	during cleaning conditions the surfaces may get hotter than usual and children should be kept away. (Cleaning function model only.)	✓	✓	
	Excess spillage must be removed before cleaning and utensils which state in cleaning manual can be left in the oven during cleaning. (Cleaning function model only.)	✓	✓	✓
	Appliance should allow to disconnection of the appliance from the supply after installation. The disconnection may be achieved by having the plug accessible or by incorporating a switch in the fixed wiring in accordance with the wiring rules. (Built-in model only.)	✓	✓	✓
	If the supply cord is damaged, it must be replaced by the manufacturer, its service agent or similarly qualified persons in order to avoid a hazard.	✓		
	<b>WARNING:</b> When the appliance is operated in the combination mode, children should only use the oven under adult supervision due to the temperatures generated.	✓		
	The temperature of accessible surfaces may be high when the appliance is operating	✓		
	The door or the outer surface may get hot when the appliance is operating	✓		

<b>CAUTION</b>					
	Only use utensils that are suitable for use in microwave ovens; DO NOT use any metallic containers, Dinnerware with gold or silver trimmings, Skewers, forks, etc. Remove wire twist ties from paper or plastic bags. Reason: Electric arcing or sparking may occur and may damage the oven.	✓		✓	✓
	When heating food in plastic or paper containers, keep an eye on the oven due to the possibility of ignition;	✓		✓	
	Do not use your microwave oven to dry papers or clothes.	✓		✓	✓
	Use shorter times for smaller amounts of food to prevent overheating and burning food.	✓		✓	✓
	If smoke is observed, switch off or unplug the appliance and keep the door closed in order to stifle any flames;	✓		✓	✓
	The oven should be cleaned regularly and any food deposits removed;	✓	✓		✓
	Do not immerse the power cable or power plug in water and keep the power cable away from heat.	✓	✓		
	Eggs in their shell and whole hard-boiled eggs should not be heated in microwave ovens since they may explode, even after microwave heating has ended; Also do not heat airtight or vacuum-sealed bottles, jars, containers, nuts in shells, tomatoes etc.			✓	✓
	Do not cover the ventilation slots with cloth or paper. They may catch fire as hot air escapes from the oven. The oven may also overheat and switch itself off automatically, and will remain off until it cools sufficiently.	✓		✓	
	Always use oven mitts when removing a dish from the oven to avoid unintentional burns.			✓	
	Do not touch heating elements or interior oven walls until the oven has cooled down.			✓	
	Stir liquids halfway during heating or after heating ends and allow the liquid stand at least 20 seconds after heating to prevent eruptive boiling.			✓	

	Stand at arms length from the oven when opening the door to avoid getting scalded by escaping hot air or steam.			✓
	Do not operate the microwave oven when it is empty. The microwave oven will automatically shut down for 30 minutes for safety purposes. We recommend placing a glass of water inside the oven at all times to absorb microwave energy in case the microwave oven is started accidentally.	✓		✓
	Do not use harsh abrasive cleaners or sharp metal scrapers to clean the oven door glass since they can scratch the surface, which may result in shattering of the glass.	✓		✓
	Install the oven in compliance with the clearances stated in this manual. (See installing your microwave oven.)	✓		✓
	Take care when connecting other electrical appliances to sockets near the oven.	✓	✓	✓



## **CORRECT DISPOSAL OF THIS PRODUCT (WASTE ELECTRICAL & ELECTRONIC EQUIPMENT)**

### **(Applicable in countries with separate collection systems)**

This marking on the product, accessories or literature indicates that the product and its electronic accessories (e.g. charger, headset, USB cable) should not be disposed of with other household waste at the end of their working life. To prevent possible harm to the environment or human health from uncontrolled waste disposal, please separate these items from other types of waste and recycle them responsibly to promote the sustainable reuse of material resources.

Household users should contact either the retailer where they purchased this product, or their local government office, for details of where and how they can take these items for environmentally safe recycling.

Business users should contact their supplier and check the terms and conditions of the purchase contract. This product and its electronic accessories should not be mixed with other commercial wastes for disposal.

For information on Samsung's environmental commitments and product specific regulatory obligations e.g. REACH, WEEE, Batteries, visit : [www.samsung.com/uk/aboutsamsung/sustainability/environment/our-commitment/data/](http://www.samsung.com/uk/aboutsamsung/sustainability/environment/our-commitment/data/)

## **INSTALLATION & WIRING INSTRUCTIONS**

### **IMPORTANT NOTE :**

The mains lead on this equipment is supplied with a moulded plug incorporating a fuse.

The value of the fuse is indicated on the pin face of the plug and, if it requires replacing, a fuse approved to BS1363 of the same rating must be used.

Never use the plug with the fuse cover omitted if the cover is detachable. If a replacement fuse cover is required, it must be of the same colour as the pin face of the plug.

Replacement covers are available from your Dealer. If the fitted plug is not suitable for the power points in your house or the cable is not long enough to reach a power point, you should obtain a suitable safety approved extension lead or consult your Dealer for assistance. However, if there is no alternative to cutting off the plug, remove the fuse and then safely dispose of the plug. Do not connect the plug to a mains socket, as there is a risk of shock hazard from the bared flexible cord.

### **LAMP (LIGHT SOURCE)**

This product contains a light source of energy efficiency class < G >.

The lamps and control gears are not user-serviceable. To replace the lamps or control gears of the product, contact a local Samsung service centre.

## OVEN

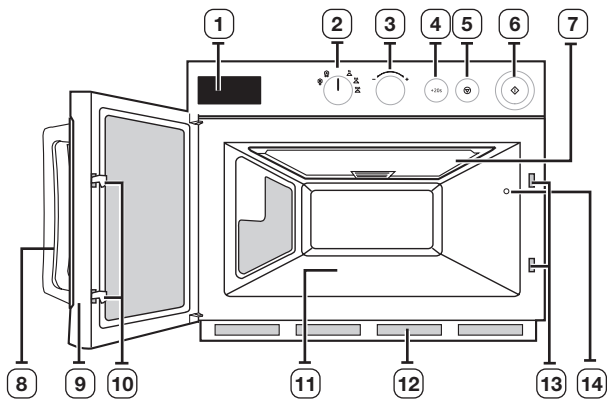

- |                       |                            |
|-----------------------|----------------------------|
| 1. DISPLAY            | 8. DOOR HANDLE             |
| 2. POWER CONTROL DIAL | 9. DOOR                    |
| 3. TIMER DIAL         | 10. DOOR LATCHES           |
| 4. +20s BUTTON        | 11. PLATE TRAY             |
| 5. CANCEL BUTTON      | 12. AIR FILTER             |
| 6. START BUTTON       | 13. SAFETY INTERLOCK HOLES |
| 7. CEILING COVER      | 14. OVEN LAMP              |

## DISPLAY

1. TIME DISPLAY
2. POWER LEVEL INDICATORS
3. DEFROST INDICATORS

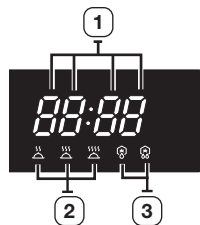

## SETTING THE TIME

Your microwave oven has an inbuilt clock. When power is supplied, “:0”, “88:88” or “12:00” is automatically displayed on the display.

Please set the current time. The time can be displayed in either the 24-hour or 12-hour notation. You must set the clock:

- When you first install your microwave oven
- After a power failure

Do not forget to reset the clock when you switch to and from summer and winter time.

### Auto energy saving function.

If you do not select any function when appliance is in the middle of setting or operating with temporary stop condition, function is canceled and clock will be displayed after 25 minutes.

Oven Lamp will be turned off after 5 minutes with door open condition.

1. To display the time in the... Then press ‘+20s’

24-hour notation	Once
12-hour notation	Twice

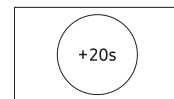

2. Turn the **TIMER DIAL** to set the hour.

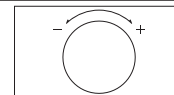

3. Press the **START** button.

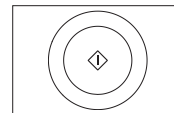

4. Turn the **TIMER DIAL** to set the minutes.

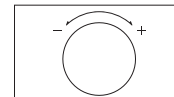

5. When the right time is displayed, press the **START BUTTON** to start the clock. The clock sets itself within 10 seconds.

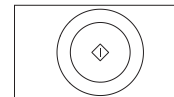

If you don't want to setting the time, press the CANCEL button before starting your cooking.

If you want to change or reset the time setting, plug your oven again.

## STOPPING THE COOKING

You can stop cooking at any time so that you can:

- Check the food
- Turn the food over or stir it
- Leave it to stand

### 1. To stop the cooking temporarily:

Open the door or press (  ) Button once.

**Result :** Cooking stops.  
To resume cooking, close the door and press (  ) again.

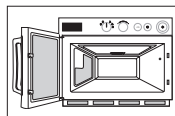



### 2. To stop the cooking completely ;

Press the (  ) Button twice.

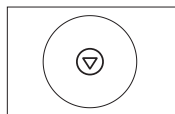
**Result :** The cooking settings are cancelled.



 If you want to cancel any cooking settings before starting cooking, simply press **CANCEL**(  ) once.

## COOKING/REHEATING

Make sure the oven is plugged into a properly earthed electrical outlet

Open the door(The oven lamp will be turned on.).

Put the food into a suitable container, place it in the centre of the oven and then close the door securely (The oven lamp will go off.).

### 1. Select the desired power level by rotating the **COOKING POWER CONTROL DIAL.**

**Result :** The selected power level will be displayed in the display window.

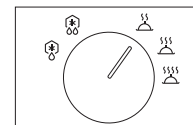
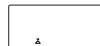

### 2. Set the desired heating time by rotating the **TIMER DIAL.**

**Result :** The selected time is displayed in the display window.

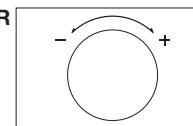
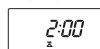

### 3. Press the button.

**Result :** The oven lamp and cooling fan will be turned on. Heating will start. The time on digital display will count down.

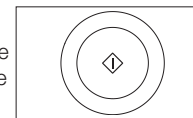
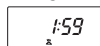

 When all time is elapsed, the end of cycle Beep Tone will sound 4 times and all heating will stop. The oven lamp will go off. For 1 min, the cooling fan will keep working in order to cool down the interior parts. During the time, the fan will not stop even when you open the door. 1 min later it will stop. Food may be removed from oven whilst the fan is still running.

4. Open the door and take the food out.  
Close the door. The oven lamp will go off.



- ✔ Whilst heating, one press on (🔴) Button stops the oven. You can restart it by pressing the (🔵) Button or a second press on (🔴) Button will cancel the selected program. When it is NOT in a heating cycle, one tap on (🔴) Button cancels the selected program. You can set the power level first and then the cooking time next, or vice versa. You can press +20s button one or more times in order to add the cooking time by 20 seconds.
- ✔ When heating cycle is completed and you open the door, the oven lamp automatically turns on and goes off 1 min later.
- ✔ When you open the door whilst in a heating cycle, the oven stops operating and the oven lamp automatically turns on for 5 min and goes off 5 min later. If you leave the oven door open for more than 5 min, the oven beeps once every minute.
- ✔ When in a heating cycle, you can not change the power level or heating time. But you can add 20 sec increments using the +20s Button. The dial may be rotated but this does not affect the current operation and the display remains the same. It becomes effective next time you set the oven manually after you finish the current heating. If you want to change the current setting, firstly stop the heating by using CANCEL Button and set desired power level and cooking time again. But when you are NOT in a heating cycle, you can change the power level and heating time. Changed values are promptly shown in the display.
- ✔ The oven is designed not to work when power level is set to "0" mode between the heating mode and the defrosting mode.
- ✔ When you first plug in the power cord, the oven beeps once and all the indicators show for 5 sec in the display window.

## POWER LEVELS AND TIME VARIATIONS

The power level function enables you to adapt the amount of energy dissipated and thus the time required to cook or reheat your food, according to its type and quantity. You can choose between the power levels below.

Power level	MJ26A6091		MJ26A6051	
	Percentage	Output	Percentage	Output
HIGH (🔴)	100 %	1850 W	100 %	1500 W
MEDIUM (🟡)	70 %	1295 W	70 %	1050 W
LOW (🟢)	50 %	925 W	50 %	750 W
HIGH DEFROST (🟡🔴)	20 %	370 W	25 %	375 W
LOW DEFROST (🟢🔴)	10 %	185 W	13 %	195 W

The cooking times given in recipes and in this booklet correspond to the specific power level indicated.

Power level	Max. Time
HIGH (🔴)	25 mins
MEDIUM (🟡)	40 mins
LOW (🟢)	40 mins
HIGH DEFROST (🟡🔴)	50 mins
LOW DEFROST (🟢🔴)	50 mins

- ✔ The maximum time available per power level is shown in the table above.  
A defrosting time can be set up to 50 min. But the time is reduced to 25 min (for HIGH) or 40 min (for MEDIUM or LOW) the moment you change the current power level (DEFROST) to other level such as HIGH, MEDIUM or LOW.
- Example :** If you set a defrosting time to 45min with the heating mode at DEFROST and if you change the power level to HIGH, the time will be automatically reduced to 25min.
- ✔ You can set the power level first and the cooking time next, and vice versa.

## USING +20S BUTTON

This is a **ONE TOUCH COOK** button.

By touching the button once, you can start heating instantly.

You can increase the cooking time by pressing the +20s button when in a heating cycle.

The cooking time increases by 20 seconds at each press on +20s button. But it can not exceed the maximum time allowed for the power level selected.

Before operating the oven, times can be increased using the **+20s** button. During the operating, time may only be added by using the **+20s** button.

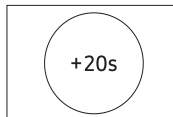

## ADJUSTING THE COOKING TIME

Like traditional cooking, you may find that, depending on the food's characteristics or your tastes, you have to adjust the cooking times slightly. You can:

- Check how cooking is progressing at any time simply by opening the door
- Close the door
- Increase the remaining cooking time

Before operating the oven, times can be increased/decreased using either the **TIMER** dial or **+20s** button. During the operating, time may only be added by using the **+20s** button.

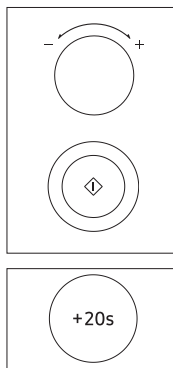

## USING THE DEFROST FEATURE

The Defrost feature enables you to defrost meat, poultry or fish.

- Only use containers that are microwave-safe.

Open the door. Place the frozen food in the centre of the plate tray. Close the door.

1. Turn the Variable Cooking Power Control dial to the **DEFROST HIGH** (☼) or **DEFROST LOW** (☼) as you wish.

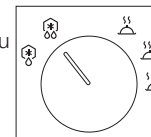

**Result :** The DEFROST indicator appears in the display.

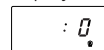

2. Rotate the **TIMER** dial to set the defrosting time.

- The Maximum time that can be set under defrosting mode is 50min.

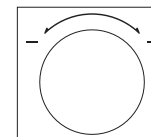
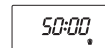

3. Press the **◇** button.

**Result :** Defrosting begins.

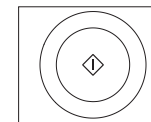
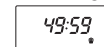

## INFORMATION CODES

Error Items	Code	Error Beep	Cause	Remedy
<b>Power frequency Error (50/60Hz)</b>	E1	One long beep for 2 sec	Power frequency is other than 50 Hz.	Unplug the power cord plug and check if the power frequency is 50 Hz.  Plug the power cord in 50 Hz power source and see if "E1" appears. If the error code is displayed again even after the correct power source is provided, contact the nearest service centre.
<b>Thermistor Open Error</b>	E21	One long beep for 2 sec	Thermistor Sensor which is supposed to sense the temperature of the cavity inside does not work properly. (Thermistor Sensor open)	Unplug the power cord and wait for more than 10 seconds. Plug the power cord again. If the symptom persists, contact the nearest service centre.
<b>Thermistor Short Error</b>	E22	One long beep for 2 sec.	Thermistor Sensor which is supposed to sense the temperature of the cavity inside does not work properly. (Thermistor Sensor short)	Unplug the power cord and wait for more than 10 seconds. Plug the power cord again. If the symptom persists, contact the nearest service centre.
<b>Temperature of exhaust air too High Error</b>	E3	One long beep for 2 sec	The oven cavity gets too hot due to excessive operation with no load or small load, or due to some blocking materials around the Air Filter or Air Exhaust at the back of the oven.	Open the oven door and check if 1) the oven has been operating with no load or too small load, 2) the air filter is placed in a wrong position, or 3) any blocking materials exist around the Air Exhaust. Cool down the oven (for approx. 30 min) under the normal temperature. The oven is back to normal when the error code "E3" disappears and "ON" appears again in the display window.  Unplug the power cord, remove the blocking materials around the ventilation openings, cool down the oven (for approx. 30 min) sufficiently, plug the power cord in again and check if the error code appears again.  If the symptom persists even when the oven is cooled down sufficiently, contact the nearest service centre.
<b>HVT-I Power Error</b>	E41	One long beep for 2 sec	The circuitry inside the oven is not working correctly.	Unplug the power cord and wait for 10 seconds. Plug the power cord in again and check if the error code "E41" appears again. If the symptom persists, contact the nearest service centre.
<b>HVT-II Power Error</b>	E42	One long beep for 2 sec	The circuitry inside the oven is not working correctly.	Unplug the power cord and wait for 10 seconds. Plug the power cord in again and check if the error code "E42" appears again. If the symptom persists, contact the nearest service centre.

## CARE OF YOUR MICROWAVE OVEN

Cleaning the Microwave Oven

1. Unplug the oven from the electrical socket before cleaning.
2. Clean the inside of the oven. Wipe up all spills with a damp cloth. Kitchen detergent solution may be used if the oven gets too dirty. Do not use harsh detergents or abrasives.
  - ☑ If food remnant or spilled liquids stick to the oven walls, or between door seal and door surface, they will absorb microwaves possibly resulting in arcing or sparks.
3. Clean the outside of the oven with soap and water, then dry with a soft cloth.
 

**CAUTION :** Make sure that water does not get into the back ventilation or control panel opening.
4. When you clean the window of the door, be sure to use a soft cloth after washing with very mild soap and water. Do not use window cleaner as the front door can be scratched by harsh soap or cleaners.

## CLEANING THE CEILING COVER

1. Hold side stoppers of ceiling cover with both hands and pull them in and down. Then take the ceiling cover out of the oven cavity.
2. Rinse ceiling cover in soapy water or Food Sanitizer Solution.
3. Be sure to replace the ceiling cover before using the oven.

**CAUTION :** Ceiling cover must be in place securely when you use the oven. When you removed the Ceiling Cover for the purpose of cleaning, be sure to be extremely careful about the exposed inside components on the top of the oven cavity. If any of them are deformed, abnormal symptom can happen such as arcing or sparks during operation. In case of such problem, contact the nearest after-sales service centre.

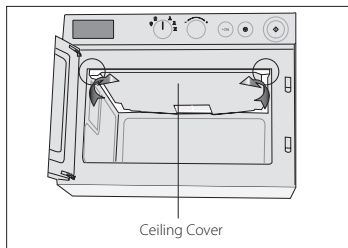

## CLEANING THE AIR FILTER

Clean the Air Filter regularly according to the following instructions.

The oven may have problems when the Air Filter becomes clogged with dust.

1. Remove the bolt at both ends of the Air Filter.
2. Lift the Air Filter off the post carefully.
3. Wash this filter in warm soapy water.
4. Be sure to replace the Air Filter before using the oven.

- ☑ If the Air Filter becomes clogged with debris, this will cause an overheating problem on the oven.

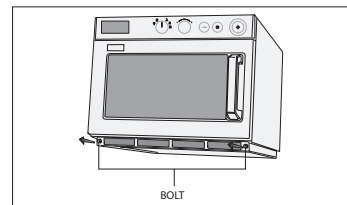

## INSTALLATION INSTRUCTIONS FOR STACKING

### Important

1. Disconnect the power cord from the wall socket before attempting installation.
2. For stacking installation, you must use the "bracket plate" which is enclosed with this unit.
3. The maximum stacking height is two units.
  - ☑ Stacking the two units is limited to the following models.
 

**CAUTION :** Be sure the oven cavity is empty.

## Installation

1. Stack two units together.
2. Remove 6 screws as shown in the figure.
3. Place the Bracket-plate to join the two units.
4. Attach and tighten 6 screws as shown in the figure here.
5. Ensure the top oven is at a safe and workable height.

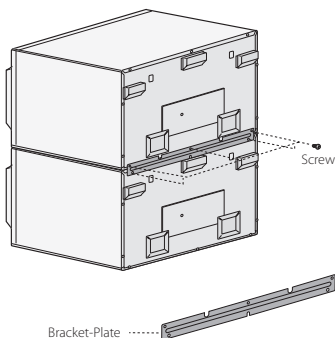

## COOKWARE GUIDE

To cook food in the microwave oven, the microwaves must be able to penetrate the food, without being reflected or absorbed by the dish used. Care must therefore be taken when choosing the cookware. If the cookware is marked microwave-safe, you do not need to worry. The following table lists various types of cookware and indicates whether and how they should be used in a microwave oven.

Cookware	Microwave-Safe	Comments
<b>Aluminum foil</b>	✓ X	Can be used in small quantities to protect areas against overcooking. Arcing can occur if the foil is too close to the oven wall or if too much foil is used.
<b>China and earthenware</b>	✓	Porcelain, pottery, glazed earthenware and bone china are usually suitable, unless decorated with a metal trim.
<b>Disposable polyester cardboard dishes</b>	✓	Some frozen foods are packaged in these dishes.
<b>Fast-food packaging</b>		
<ul style="list-style-type: none"> <li>• Polystyrene cups containers</li> </ul>	✓	Can be used to warm food. Overheating may cause the polystyrene to melt.
<ul style="list-style-type: none"> <li>• Paper bags or newspaper</li> </ul>	X	May catch fire.
<ul style="list-style-type: none"> <li>• Recycled paper or metal trims</li> </ul>	X	May cause arcing.
<b>Glassware</b>		
<ul style="list-style-type: none"> <li>• Oven-to-tableware</li> </ul>	✓	Can be used, unless decorated with a metal trim.
<ul style="list-style-type: none"> <li>• Fine glassware</li> </ul>	✓	Can be used to warm foods or liquids. Delicate glass may break or crack if heated suddenly.
<ul style="list-style-type: none"> <li>• Glass jars</li> </ul>	✓	Must remove the lid. Suitable for warming only.

Cookware	Microwave-Safe	Comments
<b>Metal</b> <ul style="list-style-type: none"> <li>Dishes</li> <li>Freezer bag twist ties</li> </ul>	<p>✗</p> <p>✗</p>	<p>May cause arcing or fire.</p>
<b>Paper</b> <ul style="list-style-type: none"> <li>Plates, cups, napkins and Kitchen paper</li> <li>Recycled paper</li> </ul>	<p>✓</p> <p>✗</p>	<p>For short cooking times and warming. Also to absorb excess moisture.</p> <p>May cause arcing.</p>
<b>Plastic</b> <ul style="list-style-type: none"> <li>Containers</li> <li>Cling film</li> <li>Freezer bags</li> </ul>	<p>✓</p> <p>✓</p> <p>✓ ✗</p>	<p>Particularly if heat-resistant thermoplastic. Some other plastics may warp or discolour at high temperatures. Do not use Melamine plastic.</p> <p>Can be used to retain moisture. Should not touch the food. Take care when removing the film as hot steam will escape.</p> <p>Only if boilable or oven-proof. Should not be airtight. Prick with a fork, if necessary.</p>
<b>Wax or grease-proof paper</b>	<p>✓</p>	<p>Can be used to retain moisture and prevent spattering.</p>

- ✓ : Recommended
- ✓✗ : Use Caution
- ✗ : Unsafe

### Cooking Guide

**F : Frozen**                      **C : Chilled**

Recipe	Method	Power Level	Timing		Stand Time
			1850W	1500W	
<b>BREAD &amp; PASTRIES</b>					
To Defrost					
Vienna Baton 9" F		DEFROST 1 (☞)	0'45"	0'50"	5 mins
Vienna Baton 9" X 2 F		DEFROST 1 (☞)	1'10"	1'15"	5 mins
Gateaux, ind. Slice F	Place on plate	DEFROST 2 (☞)	2'30"	2'40"	5 mins
To warm					
Quiche 11" sliced 136g	Place on plate	DEFROST 1 (☞) HIGH	3'00" 0'40"	3'00" 0'45"	1 min 1 min
Mince pies ind. X 2 F	Remove from tin foil Place on plate	HIGH	0'10"	0'15"	1 min
Fruit pie F	Place on plate	HIGH	0'40"	0'45"	1 min
Croissant X 2 F	Place on plate	HIGH	0'05"	0'10"	1 min
Pastry, baked 227g C	Place on plate	HIGH	0'45"	0'55"	1 min
Chicken & mushroom pie X 2 C	Remove foil. Place on plate	HIGH	0'45"	0'55"	1 min
Chicken & mushroom pie C	Place on plate, remove foil	HIGH	0'30"	0'40"	1 min

Recipe	Method	Power Level	Timing		Stand Time
			1850W	1500W	
SNACK & STARTERS					
To cook					
Bacon, rasher C	Place on rack	HIGH	1'30"	1'40"	1 min
Eggs, poached X 2 C	Place in ramekins	HIGH	0'30"	0'40"	1 min
Eggs, scrambled X2 C	Beat eggs and place in bowl	HIGH	25"-30"	30"-40"	1 min
Sausages X 2 Thick C	Pierce	MED	1'00"	1'10"	2 mins
To Reheat					
Sausages Cumberland F	Place on plate	MED	2'00"	2'10"	2 mins
Full breakfast C	Cover	MED	2'30"	2'40"	1 min
Beefburgers F		HIGH	0'55"	1'05"	1 min
Chickenburger F		HIGH	0'55"	1'05"	1 min
Donner kebab 162g F		HIGH	1'00"	1'10"	1 min
Hot Dog F		HIGH	1'00"	1'10"	1 min
Pizza 190g F	Place on plate	LOW	2'30"	2'45"	2 min
Chargrilled ribs 200g F	Place on plate	MED	3'30"	3'45"	1 min
Wings of fire X 6 F	Arrange on plate, thin parts to center	HIGH	2'00"	2'15"	1 min
Baked Beans 500g	Cover and Stir half way	HIGH	2'00"	2'10"	2 mins
Baked Beans 250g	Cover and Stir half way	HIGH	1'00"	1'05"	2 mins

## F : Frozen

## C : Chilled

Recipe	Method	Power Level	Timing		Stand Time
			1850W	1500W	
DESSERTS					
To warm					
Apple Crumble 200g F	Cover in dish	HIGH	1'20"	1'30"	2 mins
Christmas Pudding 150g C	Place in bowl	HIGH	0'20"	0'25"	2 mins
Jam Roly Poly 80g F	On a plate	HIGH	1'00"	1'05"	2 mins
Crepes Suzette 2 F	Pierce film	HIGH	0'50"	1'00"	1 min
Suet Sponge pudding F	X 2	HIGH	0'35"	1'05"	2 mins
	X 1	HIGH	0'40"	0'50"	2 mins
Sponge pudding F	X 2	HIGH	0'35"	1'05"	2 mins
	X 1	HIGH	0'40"	0'50"	2 mins
RECIPE DISH ENTREES					
To Reheat					
Amorini & Stilton bake C	Place in microwave safe dish	HIGH	3'30"	3'40"	1 min
Chicken Tikka masala F	Pierce film	HIGH	3'20"	3'30"	2 mins
Thai Green Chicken curry F	Pierce film	HIGH	3'00"	3'15"	2 mins
Chilli con Carne F	Pierce film	HIGH	3'30"	3'45"	2 mins
Chicken cooked 1/2 Chilled	Place in m/w in pierced bag	MED	4'30"	5'00"	2 mins

Recipe	Method	Power Level	Timing		Stand Time
			1850W	1500W	
Lasagne 192g	Place in microwave safe dish	MED	4'00"	4'15"	2 mins
Moules Marinières 466g F	Pierce bag	HIGH	2'30"	2'45"	2 mins
Salmon & Avocado Paupiette C	Pierce bag	HIGH	2'30"	2'45"	2 mins
Shepherd's pie 300g C	Place in oven and cover	MED	3'00"	3'15"	2 mins
Suet puddings chilled	Cover - place upright on microwave safe plate	LOW	4'00"	4'20"	2 mins
Supreme of chicken in red pesto 312g F	Pierce bag place on plate	DEFROST 1 (⊘)	5'00"	5'00"	1 min
		HIGH	3'30"	3'45"	
Tagliatelle carbonara C	Pierce film, place on plate	HIGH	1'40"	2'00"	1 min
Tortellini formaggio C	Place in dish and cover	HIGH	2'00"	2'15"	1 min
Vegetable Cumberland Pie C	Place in microwave safe dish	HIGH	3'20"	3'35"	1 min
Plated Meal 350g C	Covered	HIGH	2'00"	2'15"	1 min
Plated Meal 700g C	Covered	HIGH	3'00"	3'15"	1 min

## F : Frozen

## C : Chilled

Recipe	Method	Power Level	Timing		Stand Time
			1850W	1500W	
FRESH VEGETABLES					
To cook 500g					
Beans, green sliced	60ml/4tbsps water cover	HIGH	3'00"	3'15"	2 mins
Broccoli, florets	60ml/4tbsps water cover	HIGH	3'00"	3'15"	2 mins
Cabbage, shredded	10tbsps water cover	HIGH	5'00"	5'30"	2 mins
Carrots, sliced	60ml/4tbsps water cover	HIGH	3'30"	3'45"	2 mins
Cauliflower, florets	60ml/4tbsps water cover	HIGH	3'30"	3'45"	2 mins
Whole Green beans	60ml/4tbsps water cover	HIGH	3'30"	3'45"	2 mins
Potatoes, jacket	Turn half way	HIGH	10'00"	11'00"	5 mins
Sprouts	60ml/4tbsps water cover	HIGH	4'30"	4'45"	2 mins
Beans, green sliced	Cover, stir half way through cooking	HIGH	3'00"	3'15"	2 mins
Beans, whole	Cover, stir half way	HIGH	4'00"	4'15"	2 mins
Broccoli Florets	Cover, stir half way	HIGH	4'00"	4'15"	2 mins
Cabbage, shredded	Cover, stir half way	HIGH	4'00"	4'15"	2 mins
Carrot batons	Cover, stir half way	HIGH	4'00"	4'15"	2 mins
Cauliflower, florets	Cover, stir half way	HIGH	4'00"	4'15"	2 mins



Recipe	Method	Power Level	Timing		Stand Time
			1850W	1500W	
Corn on the Cob	Cover	HIGH	4'00"	4'30"	2 mins
Corn, whole baby	Cover, stir half way	HIGH	5'00"	3'15"	2 mins
Mushrooms, whole	Cover, stir half way	HIGH	3'00"	3'15"	2 mins
FRESH VEGETABLES					
To cook 500g					
Potatoes, jacket 230~290g X 1		HIGH	3'00"	4'00"	2 mins
Potatoes, Mashed X 2 Potatoes, Mashed X 4		HIGH	6'00"	6'30"	2 mins
		HIGH	10'00"	11'15"	2 mins
Ratatouille 500g		HIGH	3'30"	4'00"	2 mins
Sprouts	Cover, stir half way	HIGH	3'00"	3'30"	2 mins
RICE, 500g					
To Reheat					
Rice, boiled F	Cover, stir half way	HIGH	3'00"	3'15"	2 mins
Rice, Pilau F	Cover, stir half way	HIGH	3'00"	3'15"	2 mins

## CLEANING YOUR MICROWAVE OVEN

The following parts of your microwave oven should be cleaned regularly to prevent grease and food particles from building up:

- Inside and outside surfaces
- Door and door seals
- Plate tray

- ☑ **ALWAYS** ensure that the door seals are clean and the door closes properly.
- ☑ Failure to maintain the oven in a clean condition could lead to deterioration of the surface that could adversely affect the of the appliance and possibly result in a hazardous situation.

1. Clean the outside surfaces with a soft cloth and warm, soapy water. Rinse and dry.
2. Remove any splashes or stains on the inside surfaces or on the roller ring with a soapy cloth. Rinse and dry.
3. To loosen hardened food particles and remove smells, place a cup of diluted lemon juice on the turntable and heat for ten minutes at maximum power.

- ☑ **DO NOT** spill water in the vents.

**NEVER** use any abrasive products or chemical solvents.

- ☑ Take particular care when cleaning the door seals to ensure that no particles:
  - Accumulate
  - Prevent the door from closing correctly
- ☑ **Clean the** microwave oven cavity right after each use with a mild detergent solution, but let the microwave oven cool down before cleaning in order to avoid injury.

## STORING AND REPAIRING YOUR MICROWAVE OVEN

A few simple precautions should be taken when storing or having your microwave oven serviced.

The oven must not be used if the door or door seals are damaged:

- Broken hinge
- Deteriorated seals
- Distorted or bent oven casing

Only a qualified microwave service technician should perform repair.

- ☑ **NEVER** remove the outer casing from the oven. If the oven is faulty and needs servicing or you are in doubt about its condition:
  - Unplug it from the wall socket
  - Contact the nearest after-sales service centre

## TECHNICAL SPECIFICATIONS

SAMSUNG strives to improve its products at all times. Both the design specifications and these user instructions are thus subject to change without notice.

Model	MJ26A6091	MJ26A6051
Power source	230-240 V ~ 50 Hz	
Power consumption Microwave	13 A	12.7 A
Output power	1850 W (IEC-705) 240 V : 1850 W 230 V : 1780 W	1500W (IEC-705) 240 V : 1500 W 230 V : 1450 W
Operating frequency	2450 MHz	
Dimensions (W x H x D)		
Outside	464 x 368 x 557 mm	
Oven cavity	370 x 190 x 370 mm	
Volume	26 liter	
Weight Net	33.1 kg approx	

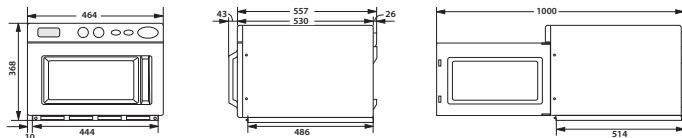

## MEMO

**MEMO**

---

**MEMO**

---

**ENGLISH**

## QUESTIONS OR COMMENTS?

COUNTRY	CALL	OR VISIT US ONLINE AT
AUSTRIA	0800 72 67 864 (0800-SAMSUNG)	<a href="http://www.samsung.com/at/support">www.samsung.com/at/support</a>
BELGIUM	02-201-24-18	<a href="http://www.samsung.com/be/support">www.samsung.com/be/support</a> (Dutch) <a href="http://www.samsung.com/be_fr/support">www.samsung.com/be_fr/support</a> (French)
DENMARK	707 019 70	<a href="http://www.samsung.com/dk/support">www.samsung.com/dk/support</a>
FINLAND	030-6227 515	<a href="http://www.samsung.com/fi/support">www.samsung.com/fi/support</a>
FRANCE	01 48 63 00 00	<a href="http://www.samsung.com/fr/support">www.samsung.com/fr/support</a>
GERMANY	06196 77 555 77	<a href="http://www.samsung.com/de/support">www.samsung.com/de/support</a>
ITALIA	800-SAMSUNG (800.7267864)	<a href="http://www.samsung.com/it/support">www.samsung.com/it/support</a>
CYPRUS	8009 4000 only from landline, toll free	<a href="http://www.samsung.com/gr/support">www.samsung.com/gr/support</a>
GREECE	80111-SAMSUNG (80111 726 7864) only from land line (+30) 210 6897691 from mobile and land line	<a href="http://www.samsung.com/gr/support">www.samsung.com/gr/support</a>
LUXEMBURG	261 03 710	<a href="http://www.samsung.com/be_fr/support">www.samsung.com/be_fr/support</a>
NETHERLANDS	088 90 90 100	<a href="http://www.samsung.com/nl/support">www.samsung.com/nl/support</a>
NORWAY	21629099	<a href="http://www.samsung.com/no/support">www.samsung.com/no/support</a>
PORTUGAL	808 207 267	<a href="http://www.samsung.com/pt/support">www.samsung.com/pt/support</a>
SPAIN	91 175 00 15	<a href="http://www.samsung.com/es/support">www.samsung.com/es/support</a>
SWEDEN	0771 726 786	<a href="http://www.samsung.com/se/support">www.samsung.com/se/support</a>
SWITZERLAND	0800 726 786	<a href="http://www.samsung.com/ch/support">www.samsung.com/ch/support</a> (German) <a href="http://www.samsung.com/ch_fr/support">www.samsung.com/ch_fr/support</a> (French)
UK	0333 000 0333	<a href="http://www.samsung.com/uk/support">www.samsung.com/uk/support</a>
IRELAND (EIRE)	0818 717100	<a href="http://www.samsung.com/ie/support">www.samsung.com/ie/support</a>

